



Luminaire Schedule (Issue: April 26, 2022)		Project No. 0000		Sebastopol Self Storage			
Contact Kaz Halcovich with Commercial Lighting Industries, 800-755-0155 x226, kaz@Commercial-Lighting.net for pricing							
Fixture Type	Reference Image	Description	Product Registration ID	Lamps, CCT, Lumen, Optics, CRI	Input Voltage	Fixture Wattage	Mounting, Finishes, Remarks & Other Notes
ARCHITECTURAL FIXTURE TYPES							
P4		LED Area Light with type IV distribution	CLI-OOSSP4	LED Integrated, 4000K, 18,000Lm, Type IV Distribution	UNI-VACU	135	Pole mounted at 20'0 AFG. Finish TBD. Control options available.
WP		LED Wall Pack	CLI-OOSSWP	LED Integrated, 4000K, 5500Lm, Type 4 Distribution	UNI-VACU	45	Wall mounted at 10'0" AFG. Finish TBD. Control options available.
SUBSTITUTIONS ARE NOT ALLOWED AND VALUE ENGINEERING WILL NOT BE CONSIDERED WITHOUT EXPRESSED WRITTEN APPROVAL FROM THE ARCHITECT OR OWNER. NO EXCEPTIONS.							
CNTRL		Controls Package - TBD					
Notes, Exceptions, Clarifications							
PURCHASING: All Lighting is supplied by CLI. Consult with the above listed Mfgs for pricing at pre-established customer pricing. The complete package is approved and available at established discounted pricing from Commercial Lighting Industries, 81161 Indio Blvd, Indio, CA 92201, 800-755-0155. Contact Kaz Halcovich, kaz@Commercial-Lighting.net, for purchase order placement, and coordinating delivery of the package.							
LTG SPEC VERIFICATION: Purchaser assumes responsibility for, and must verify with CLI the following prior to purchasing: Voltage, specific mounting details (including recessed downlight hanger bars if non-standard from the Mfg), NYC or Chicago codes, IC Rating, wind/gust pole factors, integral luminaire wiring gauge, custom reflector reflectances, Kelvin temperature, distribution, emergency use and dimming method. The above catalog #s may not be completely solidified at time of drawing issuance for construction.							
PHOTOMETRIC COMPLIANCE: A complete Photometric drawing for this project as currently drawn and specified, has been submitted to approving authorities a applicable. Any substitutions or changes nullify the report and compliance and are strictly forbid without writtent approval from the owner, architect or lighting designer - <u>NO SUBSTITUTIONS ARE ALLOWED.</u>							
ENERGY COMPLIANCE: The purchasing party is responsible for solidifying the lighting package in compliance with the State Energy Code, both with respect to Lighting Power Density (LPD) and the use of mandated controls (dimmers, photocells, occupancy sensors, etc.). Consult with Istvan Derzsi, Sr. Lighting Designer of Commercial Lighting Industries 323-905-2220 to ensure compliance prior to ordering.							
CONTROLS: The control system being implemented has been designed per meetings with the owner and architect, determining the complete requirements of the control system, and engineered to the exact specifications of the luminaires in this schedule, and in compliance with the State Energy Code. Any changes to the above would affect the Controls engineering and thus would require re-submission to all parties: Owner, Architect, Lighting Designer, Controls Manufacturer and the State Energy Compliance Department.							
DIMMING: The method of dimming each fixture type (generally either Non-Dim, ELV/MLV, 0-10v or DALI/Ecosystem) may not have been known at the time the of preliminary specifications submission. Some luminaires may be available with different dimming than is indicated - see the catalog cuts. When requesting a quotation, and ordering, the purchaser must verify the dimming method desired (to match the wiring and type of dimming that will get installed) of each type and request the quotation accordingly. Once product is on site, the dimming installed will have to be compatible with the luminaires. Note: the default dimming specifications are: For CA, US - all 0-10V wherever possible if using central Control System - same. Otherwise, any luminaire that is not 0-10V or combo ELV/120V, is specified as ELV because it cannot be assumed that LV wiring will be run.							
WIRING: 120V Leading Edge dimmers (old technology for mostly incandescent fixtures) aka Triac/120V dimming, and 120V Trailing Edge dimmers aka ELV dimming (utilizing standard 3 wire White/Black/Green) are not interchangeable with 0-10V dimming which has two additional low voltage wires (Grey/Violet) for analog control signal, using one volt increments from 0 to 10, thus dimming the LED fixtures down to 10% or even 1%. Each fixture much be ordered with the appropriate 120V or the 0-10V driver depending on which will dim it, they are NOT interchangeable. Do Not assume a fixture with 0-10V is "standard" and will thus dim correctly if only 120V dimming is available.							
VOLTAGE: Voltage to be verified. See Volt column: DV means Dual-Volt - fixtures come compatible for either 120 or 277V. MV means Multi-Volt - fixtures come compatible for either 120/208/240/277/347 volts. TBD means the fixture comes in 120 or 277 but not both and thus the voltage for these fixtures must be verified prior to ordering.							

AREA/SITE LIGHTER

FEATURES

- Low profile LED area/site luminaire with a variety of IES distributions for lighting applications such as retail, commercial and campus parking lots
- Featuring Micro Strike Optics which maximizes target zone illumination with minimal losses at the house-side, reducing light trespass issues
- Visual comfort standard
- Compact and lightweight design with low EPA
- 3G rated for high vibration applications including bridges and overpasses
- Control options including photo control, occupancy sensing, NX Distributed Intelligence™ and 7-Pin with networked controls
- Best in class surge protection available



CONTROL TECHNOLOGY



SPECIFICATIONS

CONSTRUCTION

- Rectilinear form mimics the traditional shoebox form factor keeping a similar but updated style and appearance, ideal for retrofit applications
- Die-cast housing with hidden vertical heat fins that are optimal for heat dissipation while keeping a clean smooth outer surface
- Corrosion resistant, die-cast aluminum housing with powder coat paint finish

OPTICS

- Entire optical aperture illuminates to create a larger luminous surface area resulting in a low glare appearance without sacrificing optical performance
- 80, 160, 320 or 480 midpower LEDs
- 3000K, 4000K or 5000K (70 CRI) CCT
- Zero uplight at 0 degrees of tilt
- Field rotatable optics

INSTALLATION

- Standard square arm mount, compatible with B3 drill pattern
- Optional universal mounting block for ease of installation during retrofit applications. Available as an option or accessory for square and round poles.
- Knuckle arm fitter option available for 2-3/8" OD tenon. Max tilt of 60 degrees with 4 degree adjustable increments. (Restrictions apply for 7-pin options)

ELECTRICAL

- Universal 120-277 VAC or 347-480 VAC input voltage, 50/60 Hz

ELECTRICAL (CONTINUED)

- Ambient operating temperature -40°C to 40°C
- Drivers have greater than 90% power factor and less than 20% THD
- LED drivers have output power over-voltage, over-current protection and short circuit protection with auto recovery
- Field replaceable surge protection device provides 20kA protection meeting ANSI/IEEE C62.41.2 Category C High and Surge Location Category C3; Automatically takes fixture off-line for protection when device is compromised

CONTROLS

- Photo control, occupancy sensor and wireless available for complete on/off and dimming control
- 7-pin ANSI C136.41-2013 photocontrol receptacle option available for twist lock photocontrols or wireless control modules (control accessories sold separately)
- 0-10V dimming leads available for use with control devices (provided by others, must specify lead length)
- SiteSync™ wireless control system is available via 7-pin See ordering information and details at: www.hubbellighting.com/sitesync
- NX Distributed Intelligence™ available with in fixture wireless control module, features dimming and occupancy sensor
- wiSCAPE® available with in fixture wireless control module, features dimming and occupancy sensor via 7-pin

CERTIFICATIONS

- DLC® (DesignLights Consortium Qualified), with some Premium Qualified configurations. Please refer to the DLC website for specific product qualifications at www.designlights.org
- Listed to UL1598 and CSA C22.2#250.0-24 for wet locations and 40°C ambient temperatures
- 3G rated for ANSI C136.31 high vibration applications
- Fixture is IP66 rated
- Meets IDA recommendations using 3K CCT configuration at 0 degrees of tilt
- This product qualifies as a "designated country construction material" per FAR 52.225-11 Buy American-Construction Materials under Trade Agreements effective 04/23/2020. See Buy American Solutions

WARRANTY

- 5 year limited warranty
- See HLI Standard Warranty for additional information

KEY DATA	
Lumen Range	3,000–48,000
Wattage Range	25–340
Efficacy Range (LPW)	118–155
Fixture Projected Life (Hours)	L70>60K
Weights lbs. (kg)	13.5–24 (6.1–10.9)

ORDERING GUIDE

Example: RAR1-80L-25-3K7-2-UNV-ASQ-BL-NXWE-BC

CATALOG #

ORDERING INFORMATION

Series	# LEDs - Wattage	CCT/CRI	Distribution	Optics Rotation	Voltage
RAR1 Ratio Area Size 1	80L-25 25W - 3,000 Lumens	3K7 3000K, 70 CRI	2 IES TYPE II	Blank for no rotation	UNV Universal 120-277V
	80L-39 39W - 5,200 Lumens	4K7 4000K, 70 CRI	3 IES TYPE III	L Optic rotation left	120 120V
	80L-50 50W - 6,000 Lumens	5K7 5000K, 70 CRI	4W IES TYPE IV	R Optic rotation right	208 208V
	160L-70 70W - 9,000 Lumens		5QW IES TYPE V		240 240V
	160L-100 100W - 12,000 Lumens				277 277V
	160L-115 115W - 15,000 Lumens				347 347V
RAR2 Ratio Area Size 2	160L-135 135W - 18,000 Lumens				480 480V
	320L-110 110W - 15,000 Lumens				
	320L-140 140W - 18,000 Lumens				
	320L-165 165W - 21,000 Lumens				
	480L-185 185W - 24,000 Lumens				
	480L-210 210W - 27,000 Lumens				
	480L-240 240W - 30,000 Lumens				
	480L-255 255W - 36,000 Lumens				
	480L-295 295W - 42,000 Lumens				
	480L-340 340W - 48,000 Lumens				

Mounting	Color	Control Options Network	Options
ASQ Arm mount for square pole/flat surface	BLT Black Matte Textured	NXWE NX Wireless Enabled (module + radio)	BC Backlight control
ASQU Universal arm mount for square pole/flat surface	BLS Black Gloss Smooth	NXSPW_F NX Wireless, PIR Occ. Sensor, Daylight Harvesting ²	CD Continuous dimming
Mounting Round Poles		NXSP_F NX, PIR Occ. Sensor, Daylight Harvesting ²	F Fusing (must specify voltage)
A_ Arm mount for round pole ¹	GTT Graphite Matte Textured	Control Options Other	
A_U Universal arm mount for round pole ¹	LGS Light Grey Gloss Smooth	SCP-40F Programmable occupancy sensor ⁴	TB Terminal block
Mounting Other		7PR 7-Pin twist lock receptacle	2PF 2 power feed with 2 drivers ³
WB Wall bracket	PSS Platinum Silver Smooth	7PR-SC 7-Pin receptacle with shunting cap	
MAF Mast arm fitter for 2-3/8" OD horizontal arm	WHT White Matte Textured	7PR-MD40F Low voltage sensor for 7PR	
K Knuckle	WHS White Gloss Smooth	7PR-TL 7-Pin PCR with photocontrol	
	VGT Verde Green Textured		
	Color Option		
	CC Custom Color		

- Notes:
- 1 Replace "_" with "3" for 3.5"-4.13" OD pole, "4" for 4.18"-5.25" OD pole, "5" for 5.5"-6.5" OD pole
 - 2 Replace "_" with "14" for up to 14' mounting height, "30F" for 15-30' mounting height
 - 3 Not available with 25, 50, 255, 295 & 340W configurations
 - 4 At least one SCPREMOTE required to program SCP motion sensor

ALL EMERGENCY AND CONTROLS REQUIREMENTS TO BE DETERMINED BY THE ELECTRICAL ENGINEER

STOCK ORDERING INFORMATION

Catalog Number	Lumens	Wattage	LED Count	CCT/CRI	Voltage	Distribution	Mounting	Finish
RAR1-100-4K-3	12,000	100W	160L	4000K/70CRI	120-277V	Type 3	Square Arm	Bronze
RAR1-100-4K-4W	12,000	100W	160L	4000K/70CRI	120-277V	Type 4W	Square Arm	Bronze
RAR1-135-4K-3	18,000	135W	160L	4000K/70CRI	120-277V	Type 3	Square Arm	Bronze
RAR1-135-4K-4W	18,000	135W	160L	4000K/70CRI	120-277V	Type 4W	Square Arm	Bronze
RAR2-165-4K-3	21,000	165W	320L	4000K/70CRI	120-277V	Type 3	Square Arm	Bronze
RAR2-165-4K-4W	21,000	165W	320L	4000K/70CRI	120-277V	Type 4W	Square Arm	Bronze

AREA/SITE LIGHTER

OPTIONS AND ACCESSORIES - STOCK (ORDERED SEPARATELY)

Catalog Number	Description
<input type="checkbox"/> RARRPA3DB	Round pole adapter 3.5" to 4.13" for ASQ arm, 3.5" to 4.13" OD pole, dark bronze finish
<input type="checkbox"/> RARA3UDB	Universal mount for square pole or round pole 3.5" to 4.13", dark bronze finish
<input type="checkbox"/> RARBC80L	Ratio blacklight control 80L
<input type="checkbox"/> RARBC160L	Ratio blacklight control 160L
<input type="checkbox"/> RARBC320L	Ratio blacklight control 320L
<input type="checkbox"/> RARBC480L	Ratio blacklight control 480L

ACCESSORIES AND REPLACEMENT PARTS - MADE TO ORDER

Catalog Number	Description
<input type="checkbox"/> RAR-ASQU-XX	Universal arm mount for square pole/flat surface ²
<input type="checkbox"/> RAR-A_U-XX	Universal arm mount for round poles ^{1,2}
<input type="checkbox"/> RAR-RPA_-XX	Round pole adapter ^{1,2}
<input type="checkbox"/> SETAVP-XX	4" square pole top tenon adapter, 2 3/8" OD slipfitter ²
<input type="checkbox"/> RETAVP-XX	4" round pole top tenon adapter; 2 3/8" OD slipfitter for max. Four fixtures (90o); order 4" round pole adapters separately ²
<input type="checkbox"/> BIRD-SPIKE-3	Ratio size 1 bird deterrent/spikes
<input type="checkbox"/> BIRD-SPIKE-4	Ratio size 2 bird deterrent/spikes
<input type="checkbox"/> RARWB-XX	Wall bracket - use with Mast Arm Fitter or Knuckle ²

1 Replace "-" with "3" for 3.5"-4.13" OD pole, "4" for 4.18"-5.25" OD pole, "5" for 5.5"-6.5" OD pole

2 Replace "XX" with desired color/paint finish

CONTROLS

Standalone

SW7PR	SiteSync™ on fixture module via 7PR
SWUSB	SiteSync™ Software on USB
SWTAB	SiteSync™ Windows Tablet
SWBRG	SiteSync™ Wireless Bridge Node
SWFC	SiteSync™ Field Commission Serve
SCPREMOTE	Order at least one per project location to program and control

NXOFM-1R1D-UNV NX Wireless, Daylight Harvesting, BLE, 7 pin twisted lock

Notes:

- 1 Works with external networked photosensor
- 2 wiSCAPE Gateway required for system programming

PERFORMANCE DATA

Description	Nominal Wattage	System Watts	Dist. Type	5K (5000K NOMINAL 70 CRI)					4K (4000K NOMINAL 70 CRI)					3K (3000K NOMINAL 80 CRI)				
				Lumens	LPW	B	U	G	Lumens	LPW	B	U	G	Lumens	LPW	B	U	G
RAR1	25	25.4	2	3438	135	1	0	1	3445	136	1	0	1	3240	128	1	0	1
			3	3460	136	1	0	1	3467	136	1	0	1	3260	128	1	0	1
			4W	3406	134	1	0	1	3412	134	1	0	1	3209	126	1	0	1
			5QW	3483	137	2	0	1	3490	137	2	0	1	3282	129	2	0	1
	39	39	2	5263	139	1	0	2	5273	139	1	0	2	4960	131	1	0	2
			3	5297	139	1	0	2	5308	140	1	0	2	4991	131	1	0	2
			4W	5200	137	1	0	2	5210	137	1	0	2	4900	129	1	0	2
			5QW	5333	140	3	0	1	5344	141	3	0	1	5025	132	3	0	1
	50	49.8	2	6310	127	1	0	2	6323	127	1	0	2	5946	120	1	0	2
			3	6349	128	1	0	2	6362	128	1	0	2	5983	120	1	0	2
			4W	6233	125	1	0	2	6245	126	1	0	2	5873	118	1	0	2
			5QW	6392	129	3	0	1	6405	129	3	0	1	6023	121	3	0	1
	70	68.4	2	9486	139	1	0	2	9505	139	1	0	2	8938	131	1	0	2
			3	9544	140	1	0	2	9563	140	1	0	2	8993	131	1	0	2
			4W	9395	137	1	0	2	9414	138	1	0	2	8853	129	1	0	2
			5QW	9608	140	4	0	2	9628	141	4	0	2	9054	132	4	0	2
	100	90.0	2	11976	133	2	0	2	12000	133	2	0	2	11285	125	2	0	2
			3	12050	134	2	0	2	12074	134	2	0	2	11354	126	2	0	2
			4W	11861	132	2	0	2	11885	132	2	0	2	11177	124	2	0	2
			5QW	12131	135	4	0	2	12155	135	4	0	2	11431	127	4	0	2
	115	109.7	2	15572	142	2	0	2	15494	141	2	0	2	14871	136	2	0	2
			3	15833	144	2	0	2	15754	144	2	0	2	15121	138	2	0	2
			4W	15281	139	2	0	3	15205	139	2	0	3	14623	133	2	0	3
			5QW	15732	143	4	0	2	15653	143	4	0	2	15024	137	4	0	2
	135	133.3	2	17971	135	3	0	3	17881	134	3	0	3	17163	129	3	0	3
			3	18272	137	2	0	2	18181	136	2	0	2	17450	131	2	0	2
			4W	17635	132	2	0	3	17547	132	2	0	3	16876	127	2	0	3
			5QW	18156	136	4	0	2	18065	136	4	0	2	17339	130	4	0	2

RAR2 Performance Data on next page

* Lumen values are from photometric test performed in accordance with IESNA LM-79-08. Data is considered to be representative of the configurations shown. Actual performance may differ as a result of end-user environment and application.

PERFORMANCE DATA

Description	Nominal Wattage	System Watts	Dist. Type	5K (5000K NOMINAL 70 CRI)					4K (4000K NOMINAL 70 CRI)					3K (3000K NOMINAL 80 CRI)				
				Lumens	LPW	B	U	G	Lumens	LPW	B	U	G	Lumens	LPW	B	U	G
RAR2	110	100.3	2	15326	153	2	0	3	15357	153	2	0	3	14442	144	2	0	3
			3	15421	154	2	0	3	15452	154	2	0	3	14531	145	2	0	3
			4W	15180	151	2	0	2	15210	152	2	0	2	14304	143	2	0	2
			5QW	15525	155	4	0	2	15556	155	4	0	2	14629	146	4	0	2
	140	133.2	2	19395	146	2	0	3	19434	146	2	0	3	18276	137	2	0	3
			3	19515	147	2	0	3	19554	147	2	0	3	18389	138	2	0	3
			4W	19210	144	2	0	3	19248	145	2	0	3	18101	136	2	0	3
			5QW	19647	148	5	0	3	19686	148	5	0	3	18513	139	5	0	3
	165	153.6	2	21651	141	3	0	3	21695	141	3	0	3	20402	133	3	0	3
			3	21785	142	3	0	3	21828	142	3	0	3	20527	134	3	0	3
			4W	21444	140	3	0	3	21487	140	3	0	3	20206	132	3	0	3
			5QW	21932	143	5	0	3	21976	143	5	0	3	20666	135	5	0	3
	185	174.5	2	26046	149	3	0	3	26098	150	3	0	3	24543	141	3	0	3
			3	26207	150	3	0	3	26259	150	3	0	3	24694	142	3	0	3
			4W	25797	148	3	0	4	25849	148	3	0	4	24308	139	3	0	4
			5QW	26384	151	5	0	3	26437	152	5	0	3	24861	143	5	0	3
	210	198.2	2	28848	145	3	0	4	28906	146	3	0	4	27184	137	3	0	4
			3	29027	146	3	0	4	29085	147	3	0	4	27351	138	3	0	4
			4W	28572	144	3	0	4	28630	144	3	0	4	26924	136	3	0	4
			5QW	29222	147	5	0	4	29281	148	5	0	4	27536	139	5	0	4
	240	226.9	2	32087	141	3	0	4	32151	142	3	0	4	30235	133	3	0	4
			3	32285	142	3	0	4	32350	143	3	0	4	30422	134	3	0	4
			4W	31780	140	3	0	4	31844	140	3	0	4	29946	132	3	0	4
			5QW	32503	143	5	0	4	32568	144	5	0	4	30627	135	5	0	4
	255	257.0	2	37040	144	3	0	4	36854	143	3	0	4	35373	138	3	0	4
			3	37660	147	3	0	4	37472	146	3	0	4	35966	140	3	0	4
			4W	36347	141	3	0	5	36166	140	3	0	5	34782	135	3	0	5
			5QW	37420	146	5	0	4	37233	145	5	0	4	35736	139	5	0	4
	295	294.0	2	41733	142	3	0	4	41524	141	3	0	4	39855	136	3	0	4
			3	42432	144	3	0	4	42220	144	3	0	4	40523	138	3	0	4
			4W	40953	139	3	0	5	40748	139	3	0	5	39190	133	3	0	5
			5QW	42162	143	5	0	4	41951	143	5	0	4	40264	137	5	0	4
	340	347.1	2	48392	139	4	0	5	48150	139	4	0	5	46215	133	4	0	5
			3	49203	142	3	0	4	48957	141	3	0	4	46989	135	3	0	4
			4W	47488	137	4	0	5	47261	136	4	0	5	45443	131	4	0	5
			5QW	48889	141	5	0	5	48645	140	5	0	5	46689	135	5	0	5

* Lumen values are from photometric test performed in accordance with IESNA LM-79-08. Data is considered to be representative of the configurations shown. Actual performance may differ as a result of end-user environment and application.

AREA/SITE LIGHTER

ELECTRICAL DATA

# OF LEDS	Nominal Wattage	Input Voltage	Oper. Current (Amps)	System Power (Watts)
RAR1	25	120	0.21	25.4
		208	0.12	
		240	0.11	
		277	0.09	
	39	120	0.32	38.0
		208	0.18	
		240	0.16	
		277	0.14	
		347	0.11	
		480	0.08	
	50	120	0.42	49.8
		208	0.24	
		240	0.21	
		277	0.18	
	70	120	0.57	68.4
		208	0.33	
		240	0.29	
		277	0.25	
		347	0.21	
	100	120	0.75	90.0
		208	0.43	
		240	0.38	
		277	0.32	
		347	0.27	
	115	120	0.91	109.7
		208	0.53	
		240	0.46	
		277	0.40	
347		0.32		
480		0.23		
135	120	1.11	133.3	
	208	0.64		
	240	0.56		
	277	0.48		
	347	0.38		
		480	0.28	

# OF LEDS	Nominal Wattage	Input Voltage	Oper. Current (Amps)	System Power (Watts)
RAR2	110	120	0.84	100.3
		208	0.48	
		240	0.42	
		277	0.36	
		347	0.31	
	140	120	1.11	133.2
		208	0.64	
		240	0.56	
		277	0.48	
	165	120	1.28	153.6
		208	0.74	
		240	0.64	
		277	0.55	
	185	120	1.45	174.5
		208	0.84	
		240	0.73	
		277	0.63	
	210	120	1.65	198.3
		208	0.95	
		240	0.83	
		277	0.72	
	240	120	1.89	226.9
		208	1.09	
		240	0.95	
		277	0.82	
	255	120	2.14	257.0
		208	1.24	
		240	1.07	
		277	0.93	
		347	0.74	
	295	120	2.45	294.0
		208	1.41	
		240	1.23	
		277	1.06	
		347	0.85	
		480	0.61	
	340	120	2.89	347.1
		208	1.67	
		240	1.45	
		277	1.25	
347		1.00		
480		0.72		

LUMINAIRE AMBIENT TEMPERATURE FACTOR (LATF)

Ambient Temperature		Lumen Multiplier
0° C	32° F	1.03
10° C	50° F	1.01
20° C	68° F	1.00
25° C	77° F	1.00
30° C	86° F	0.99
40° C	104° F	0.98
50° C	122° F	0.97

Use these factors to determine relative lumen output for average ambient temperatures from 0-40°C (32-104°F).

PROJECTED LUMEN MAINTENANCE

Ambient Temperature	OPERATING HOURS					
	0	25,000	TM-21-11 L90 36,000	50,000	100,000	L70 (Hours)
25°C / 77°F	1.00	0.97	0.95	0.93	0.86	238,000
40°C / 104°F	0.99	0.96	0.95	0.93	0.85	225,000

AREA/SITE LIGHTER

DIMENSIONS

RAR1

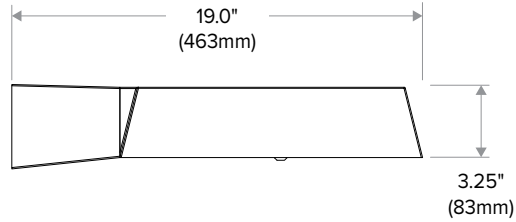
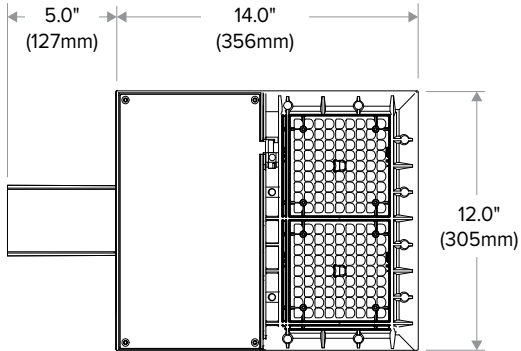

RAR2

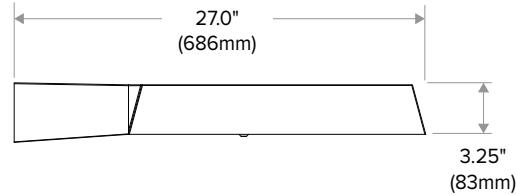
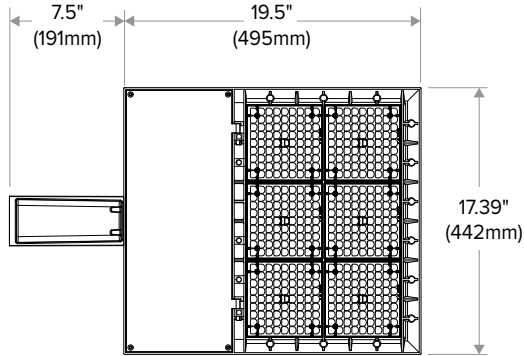

ADDITIONAL INFORMATION

MOUNTING

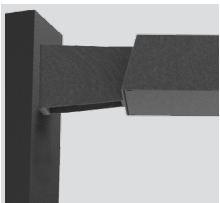

Arm Mount – Fixture ships with integral arm for ease of installation. Compatible with Hubbell Outdoor B3 drill pattern.



Knuckle – Knuckle mount 15° aiming angle increments for precise aiming and control, fits 2-3/8" tenons or pipes.



Universal Mounting – Universal mounting block for ease of installation. Compatible with drill patterns from 2.5" to 4.5"

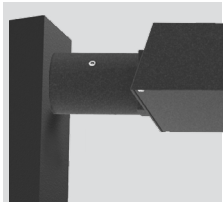

MAF – Fits 2-3/8" OD arms Roadway applications.

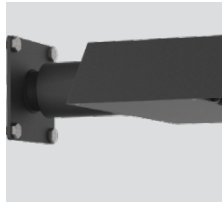

Wall Mount – Wall mount bracket designed for building mount applications.

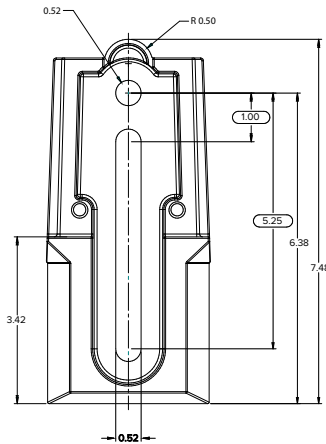

ADDITIONAL INFORMATION (CONT'D)

ARM MOUNT (ASQ)

Compatible with Pole drill pattern B3

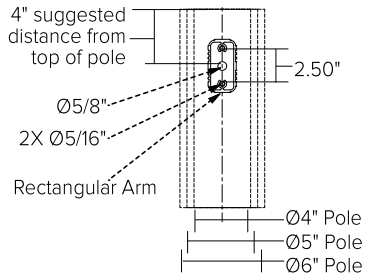

UNIVERSAL MOUNTING (ASQU)

Compatible with pole drill pattern S2

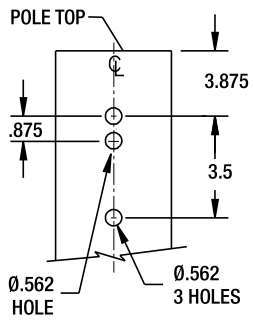

SITESYNC 7-PIN MODULE



SW7PR



- SiteSync features in a new form
- Available as an accessory for new construction or retrofit applications (with existing 7-Pin receptacle)

AREA/SITE LIGHTER

ADDITIONAL INFORMATION (CONT'D)

NXSP-14F

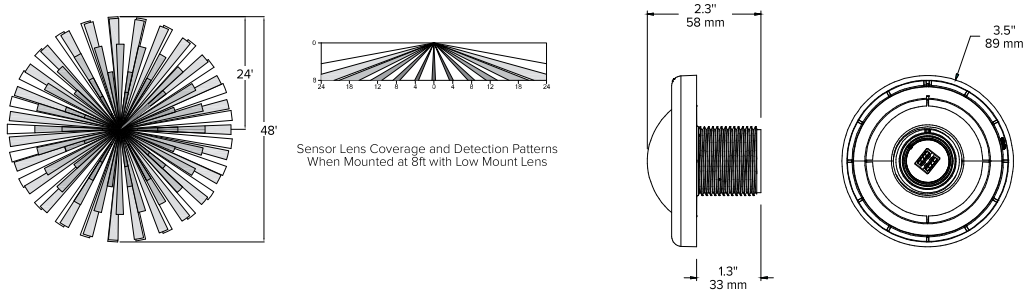

NXSP-30F

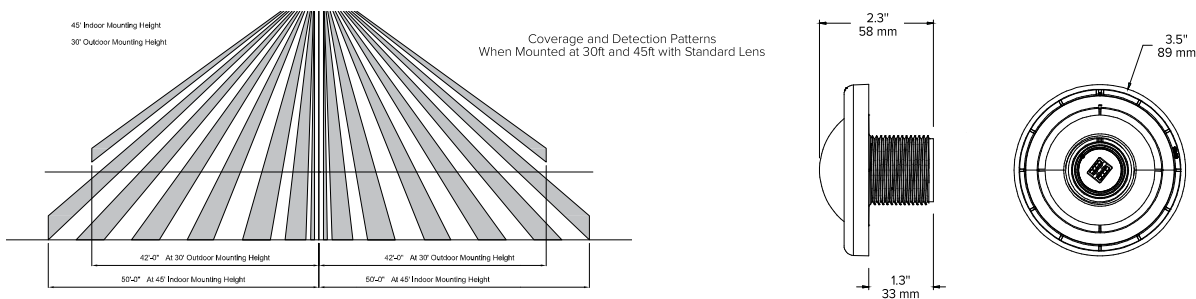

SCP-40F

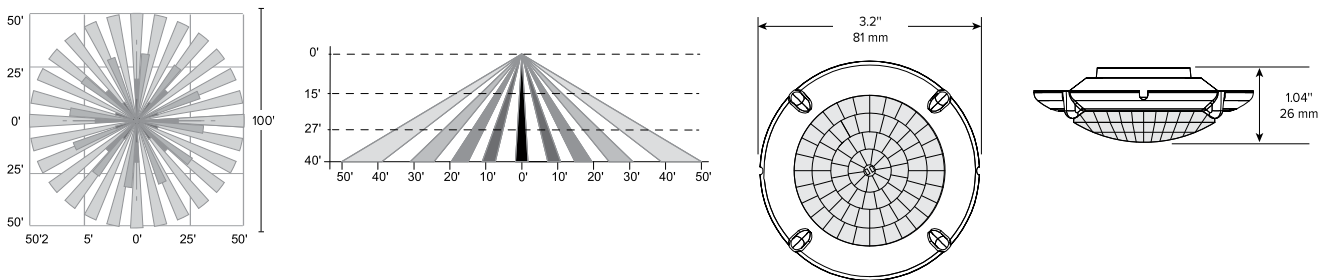

RAR1 EPA

RAR-1	
EPA at 0°	EPA at 30°
.45ft. ² .13m ²	.56ft. ² .17m ²

RAR2 EPA

RAR-2	
EPA at 0°	EPA at 30°
.55ft. ² .17m ²	1.48ft. ² .45m ²

SHIPPING

Catalog Number	G.W(kg)/CTN	Carton Dimensions		
		Length Inch (cm)	Width Inch (cm)	Height Inch (cm)
RAR1	15 (6.8)	20.75 (52.7)	15.125 (38.4)	6.9375 (17.6)
RAR2	19 (8.6)	25 (63.5)	15.125 (38.4)	6.9375 (17.6)

USE OF TRADEMARKS AND TRADE NAMES

All product and company names, logos and product identifies are trademarks™ or registered trademarks® of Hubbell Lighting, Inc. or their respective owners. Use of them does not necessarily imply any affiliation with or endorsement by such respective owners.

RWL1/RWL2 LED WALLPACK

FEATURES

- Low profile LED wall luminaire with a variety of IES distributions for lighting applications such as retail, commercial and industrial building mount
- Featuring Micro Strike Optics which maximizes target zone illumination with minimal losses at the house-side, reducing light trespass issues
- Visual comfort standard
- Control options including photo control, occupancy sensing, NX Distributed Intelligence™, Wiscap and 7-Pin with networked controls
- Battery Backup options available for emergency code compliance
- Quick-mount adapter allows easy installation/maintenance
- 347V and 480V versions for industrial applications and Canada
- Stock versions available in 3500lm and 5500lm configurations at 4000K



CONTROL TECHNOLOGY



SPECIFICATIONS

CONSTRUCTION

- Die-cast housing with hidden vertical heat fins that are optimal for heat dissipation while keeping a clean smooth outer surface
- Corrosion resistant, die-cast aluminum housing with powder coat paint finish
- Powder paint finish provides durability in outdoor environments. Tested to meet 1000 hour salt spray rating.

OPTICS

- Entire optical aperture illuminates to create a larger luminous surface area resulting in a low glare appearance without sacrificing optical performance
- 48 or 160 midpower LEDs
- 3000K, 4000K or 5000K (70 CRI/80 CRI) CCT
- Zero uplight distributions
- LED optics provide IES type II, III and IV distributions. Type II only available in RWL2 configurations.

INSTALLATION

- Quick-mount adapter provides easy installation to wall or to recessed junction boxes (4" square junction box)
- Designed for direct j-box mount.
- Integral back box contains 1/2" conduit hubs
- Integral back box standard with Dual Driver, Dual Power Feed, NX, Wiscap and battery versions (battery versions for RWL1 only)

ELECTRICAL

- 120V-277V universal voltage 50/60Hz 0-10V dimming drivers
- 347V and 480V dimmable driver option for all wattages above 35W.

ELECTRICAL (CONTINUED)

- Ambient operating temperature -40°C to 40°C
- Drivers have greater than .90 power factor and less than 20% Total Harmonic Distortion
- Driver RoHS and IP66
- Field replaceable surge protection device provides 20kA protection meeting ANSI/IEEE C62.41.2 Category C High and Surge Location Category C3; Automatically takes fixture off-line for protection when device is compromised
- Dimming drivers are standard and dimming leads are extended out of the luminaire unless control options require connection to the dimming leads. Must specify if wiring leads are to be greater than 6" standard.

CONTROLS

- Photo control, occupancy sensor and wireless available for complete on/off and dimming control
- Button photocontrol is suitable for 120-277V operation
- 7-pin ANSI C136.41-2013 photocontrol receptacle option available for twist lock photocontrols or wireless control modules (control accessories sold separately)
- NX Distributed Intelligence™ available with in fixture wireless control module, features dimming and occupancy sensor
- WISCAP® available with in fixture wireless control module, features dimming and occupancy sensor
- Integral Battery Backup provides emergency lighting for the required 90 minute path of egress
- Battery Backup suitable for operating temperatures -25°C to 40°C

CONTROLS (CONTINUED)

- Dual Driver and Dual Power Feed options creates product configuration with 2 internal drivers for code compliance
- Please consult brand or sales representative when combining control and electrical options as some combinations may not operate as anticipated depending on your application.

CERTIFICATIONS

- Listed to UL1598 and CSAC22.2#250.0-24 for wet locations
- IP65 rated housing
- This product qualifies as a "designated country construction material" per FAR 52.225-11 Buy American-Construction Materials under Trade Agreements effective 04/23/2020. See Buy American Solutions

WARRANTY

- 5 year limited warranty
- See [HLI Standard Warranty](#) for additional information

KEY DATA	
Lumen Range	1,000–19,500
Wattage Range	10–155
Efficacy Range (LPW)	118–148
Fixture Projected Life (Hours)	L70>60K
Weights lbs. (kg)	6.5/16.5 (2.9/7.5)

ORDERING GUIDE

Example: RWL1-48L-10-3K7-2-UNV-BLS-E

CATALOG #

ORDERING INFORMATION

Series	# LEDs - Wattage	CCT/CRI	Distribution	Voltage	Color
RWL1 Ratio Wall 1	48L-10 1,000 Lumens ⁴	3K7 3000K, 70 CRI	2 IES TYPE II ¹	UNV 120-277V	BLT Black Matte Textured BLS Black Gloss Smooth DBT Dark Bronze Matte Textured DBS Dark Bronze Gloss Smooth GTT Graphite Matte Textured LGS Light Grey Gloss Smooth LGT Light Grey Matte Textured PSS Platinum Silver Smooth WHT White Matte Textured WHS White Gloss Smooth VGT Verde Green Textured Color Option CC Custom Color
	48L-15 2,000 Lumens ⁴	4K7 4000K, 70 CRI	3 IES TYPE III ¹	120 120V	
	48L-20 2,500 Lumens ⁴	5K7 5000K, 70 CRI	4W IES TYPE IV	208 208V	
	48L-25 3,500 Lumens ⁴			240 240V	
	48L-35 4,500 Lumens ⁴			277 277V	
	48L-45 5,500 Lumens ⁴			347 347V	
RWL2 Ratio Wall 2	160L-45 6,500 Lumens			480 480V	
	160L-50 7,500 Lumens				
	160L-65 9,500 Lumens				
	160L-80 11,000 Lumens				
	160L-95 13,000 Lumens				
	160L-115 15,000 Lumens				
	160L-135 17,500 Lumens				
	160L-155 19,500 Lumens				

Control Options Network	
NXWE	NX Wireless Enabled (module + radio) ^{2,7}
NXSPW_F	NX Wireless, PIR Occ. Sensor, Daylight Harvesting ^{4,5,7}
NXSP_F	NX, PIR Occ. Sensor, Daylight Harvesting ^{4,5,7}
WIR	Wireless Controls, wiSCAPE™ ^{2,6}
Stand Alone Sensors	
SCP-8F	Remote control programmable line voltage sensor ^{3,4}
SCP-20F	Remote control programmable line voltage sensor ^{3,4}
Control Options	
7PR_	7-Pin Receptacle ⁶

Options	
F	Fusing (must specify voltage)
E	Emergency Battery Backup ^{7,8,9}
EH	Emergency Battery w/ Heater Option ^{7,8,9}
2DR	Dual Driver ^{4,6}
2PF	Dual Power Feed ^{4,6}
PC	Button Photocontrol ⁸

- Notes:
- 1 Only available with RWL2
 - 2 wiSCAPE Gateway required for system programming
 - 3 Specific voltage selection is required
 - 4 Not available with 480V
 - 5 Replace "_" with "14" for up to 14' mounting height, "40" for up to 40' mounting height
 - 6 This item is located in the integral backbox which will be automatically added onto the fixture if chosen.
 - 7 This item is located in the integral backbox for RWL1 configurations only.
 - 8 Option only available at 120 or 277V
 - 9 Only available with RWL1

ALL EMERGENCY AND CONTROLS REQUIREMENTS TO BE DETERMINED BY THE ELECTRICAL ENGINEER

STOCK ORDERING INFORMATION

Catalog Number	Lumens	Wattage	LED Count	CCT/CRI	Voltage	Distribution	Finish
RWL1-48L-25-4K-3	3500lm	25	48L	4000K/70CRI	120-277V	Type III	Dark Bronze Textured
RWL1-48L-25-4K-4W	3500lm	25	48L	4000K/70CRI	120-277V	Type IV Wide	Dark Bronze Textured
RWL1-48L-45-4K-3	5500lm	45	48L	4000K/70CRI	120-277V	Type III	Dark Bronze Textured
RWL1-48L-45-4K-4W	5500lm	45	48L	4000K/70CRI	120-277V	Type IV Wide	Dark Bronze Textured

CONTROLS

Control Options	
Standalone	
SCPREMOTE	Order at least one per project location to program and control

ACCESSORIES AND REPLACEMENT PARTS - MADE TO ORDER

Catalog Number	Description
<input type="checkbox"/> WP-BB-XXX	Accessory for conduit entry ¹

- Notes:
- 1 replace "xxx" with color option

PERFORMANCE DATA

Description	Nominal Wattage	System Watts	Dist. Type	5K (5000K NOMINAL 70 CRI)					4K (4000K NOMINAL 70 CRI)					3K (3000K NOMINAL 70 CRI)					
				Lumens	LPW	B	U	G	Lumens	LPW	B	U	G	Lumens	LPW	B	U	G	
RWL1	10	10.1	3	1362	135	0	0	1	1355	134	0	0	1	1303	129	0	0	1	
			4W	1343	133	0	0	1	1336	132	0	0	1	1285	127	0	0	1	
	15	14.5	3	1972	136	1	0	1	1962	135	1	0	1	1887	130	1	0	1	
			4W	1945	134	0	0	1	1935	133	0	0	1	1861	128	0	0	1	
	20	19.9	3	2722	137	1	0	1	2709	136	1	0	1	2605	131	1	0	1	
			4W	2685	135	1	0	1	2672	134	1	0	1	2569	129	1	0	1	
	25	28.0	3	3749	134	1	0	1	3732	133	1	0	1	3588	128	1	0	1	
			4W	3698	132	1	0	1	3680	131	1	0	1	3538	126	1	0	1	
	35	36.9	3	4751	129	1	0	2	4728	128	1	0	2	4546	123	1	0	1	
			4W	4685	127	1	0	2	4663	126	1	0	2	4483	121	1	0	2	
	45	46.5	3	5812	125	1	0	2	5784	124	1	0	2	5562	120	1	0	2	
			4W	5731	123	1	0	2	5704	123	1	0	2	5485	118	1	0	2	
	RWL2	45	46.1	2	6701	145	1	0	2	6668	145	1	0	2	6412	139	1	0	2
				3	6812	148	1	0	2	6780	147	1	0	2	6519	141	1	0	2
4W				6678	145	1	0	2	6646	144	1	0	2	6390	139	1	0	2	
50		54.0	2	7747	143	1	0	2	7710	143	1	0	2	7413	137	1	0	2	
			3	7876	146	1	0	2	7838	145	1	0	2	7537	140	1	0	2	
			4W	7720	143	1	0	2	7683	142	1	0	2	7388	137	1	0	2	
65		67.2	2	9539	142	1	0	2	9494	141	1	0	2	9129	136	1	0	2	
			3	9699	144	2	0	2	9652	144	2	0	2	9281	138	2	0	2	
			4W	9507	141	2	0	2	9461	141	2	0	2	9097	135	2	0	2	
80		80.8	2	11228	139	2	0	2	11174	138	2	0	2	10745	133	2	0	2	
			3	11416	141	2	0	2	11361	141	2	0	2	10924	135	2	0	2	
			4W	11190	138	2	0	2	11136	138	2	0	2	10708	133	2	0	2	
95		93.2	2	13148	141	2	0	2	13085	140	2	0	2	12582	135	2	0	2	
			3	13368	143	2	0	2	13304	143	2	0	2	12792	137	2	0	2	
			4W	13103	141	2	0	2	13040	140	2	0	2	12539	135	2	0	2	
115		109.8	2	15102	138	2	0	3	15030	137	2	0	3	14452	132	2	0	3	
			3	15354	140	2	0	3	15281	139	2	0	3	14693	134	2	0	3	
			4W	15050	137	2	0	3	14978	136	2	0	3	14402	131	2	0	3	
135		137.1	2	17533	128	2	0	3	17449	127	2	0	3	16778	122	2	0	3	
			3	17826	130	2	0	3	17740	129	2	0	3	17058	124	2	0	3	
			4W	17473	127	2	0	3	17389	127	2	0	3	16720	122	2	0	3	
155		156.8	2	19495	124	2	0	3	19402	124	2	0	3	18656	119	2	0	3	
			3	19821	126	2	0	3	19726	126	2	0	3	18967	121	2	0	3	
			4W	19542	125	2	0	3	19448	124	2	0	3	18700	119	2	0	3	

**LUMINAIRE AMBIENT
TEMPERATURE FACTOR (LATF)**

Ambient Temperature		Lumen Multiplier
0°C	32°F	1.03
10°C	50°F	1.01
20°C	68°F	1.00
25°C	77°F	1.00
30°C	86°F	0.99
40°C	104°F	0.98
50°C	122°F	0.97

Use these factors to determine relative lumen output for average ambient temperatures from 0-40°C (32-104°F).

PROJECTED LUMEN MAINTENANCE

Ambient Temperature	OPERATING HOURS					
	0	25,000	TM-21-11 L90 36,000	50,000	100,000	L70 (Hours)
25°C / 77°F	1.00	0.97	0.96	0.95	0.91	408,000
40°C / 104°F	0.99	0.96	0.95	0.94	0.89	356,000

ELECTRICAL DATA

# OF LEDS	Nominal Wattage	Input Voltage	Oper. Current (Amps)	System Power (Watts)
RWL1	10	120	0.08	10.1
		208	0.05	
		240	0.04	
		277	0.04	
		347	0.03	
		480	0.02	
	15	120	0.12	14.5
		208	0.07	
		240	0.06	
		277	0.05	
		347	0.04	
		480	0.03	
	20	120	0.17	19.9
		208	0.10	
		240	0.08	
		277	0.07	
		347	0.06	
		480	0.04	
	25	120	0.23	28.0
		208	0.13	
		240	0.12	
		277	0.10	
		347	0.08	
		480	0.06	
35	120	0.31	36.9	
	208	0.18		
	240	0.15		
	277	0.13		
	347	0.11		
	480	0.08		
45	120	0.39	46.5	
	208	0.22		
	240	0.19		
	277	0.17		
	347	0.13		
	480	0.10		

# OF LEDS	Nominal Wattage	Input Voltage	Oper. Current (Amps)	System Power (Watts)
RWL2	45	120	0.38	46.1
		208	0.22	
		240	0.19	
		277	0.17	
		347	0.13	
		480	0.10	
	50	120	0.45	54.0
		208	0.26	
		240	0.23	
		277	0.19	
		347	0.16	
		480	0.11	
	65	120	0.56	67.2
		208	0.32	
		240	0.28	
		277	0.24	
		347	0.19	
		480	0.14	
	80	120	0.67	80.8
		208	0.39	
		240	0.34	
		277	0.29	
		347	0.23	
		480	0.17	
	95	120	0.78	93.2
		208	0.45	
		240	0.39	
		277	0.34	
		347	0.27	
		480	0.19	
	115	120	0.92	109.8
		208	0.53	
		240	0.46	
		277	0.40	
		347	0.32	
		480	0.23	
	135	120	1.14	137.1
		208	0.66	
		240	0.57	
		277	0.49	
		347	0.40	
		480	0.29	
155	120	1.31	156.8	
	208	0.75		
	240	0.65		
	277	0.57		
	347	0.45		
	480	0.33		

PHOTOMETRY

Mounting Height: 30ft

Type II

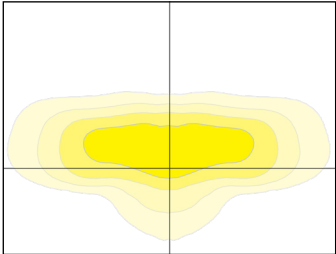

Type III

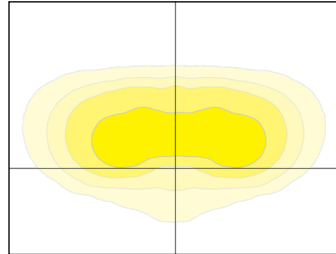

Type VI

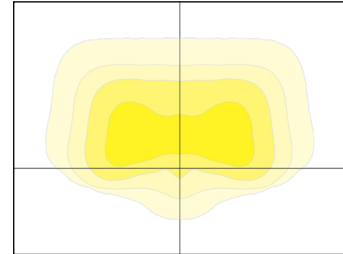

DIMENSIONS

RWL1

RWL2

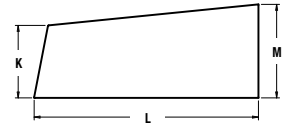
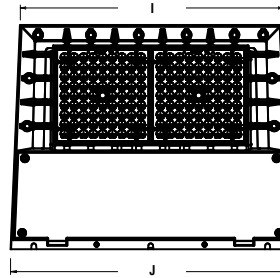
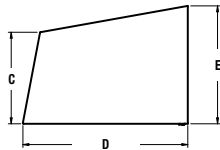
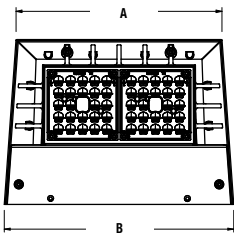

A	B	C	D	E
8.7"	9.7"	3.9"	7.0"	5.0"
221mm	246mm	99mm	178mm	127mm

Weight
6.5 lbs (2.95 kgs)

I	J	K	L	M
14.0"	15.0"	3.9"	12.0"	5.0"
356mm	381mm	99mm	305mm	127mm

Weight
16.5 lbs (7.48 kgs)

RWL1 with Integral Back Box

RWL2 with Integral Back Box

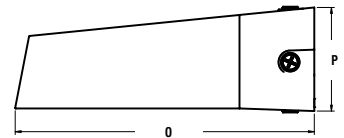
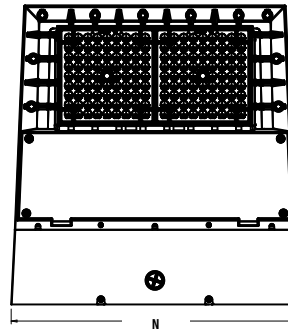
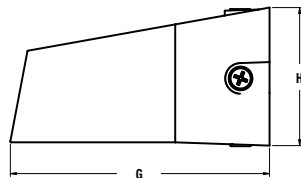
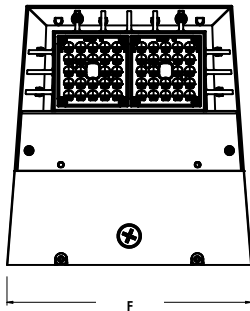

F	G	H
10.4"	11.0"	5.9"
264mm	279mm	150mm

N	O	P
15.4"	16.0"	5.5"
391mm	406mm	140mm

DIMENSIONS (CONTINUED)

Back Box Accessory

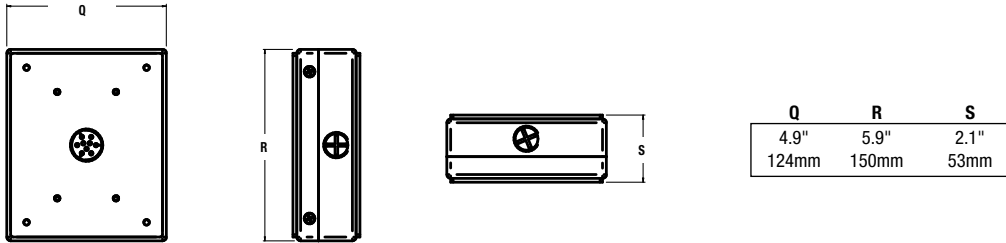

ADDITIONAL INFORMATION

NXSP-14F

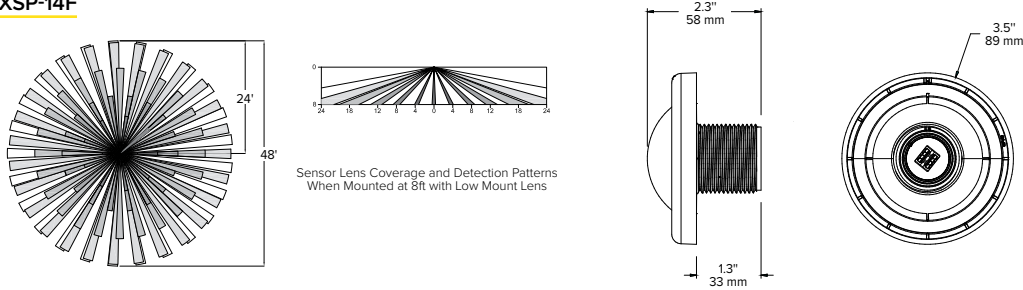

NXSP-40F

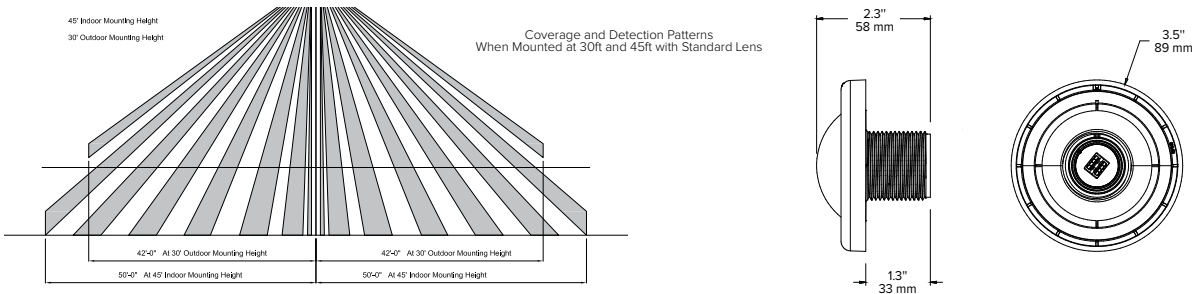

SCP-8F

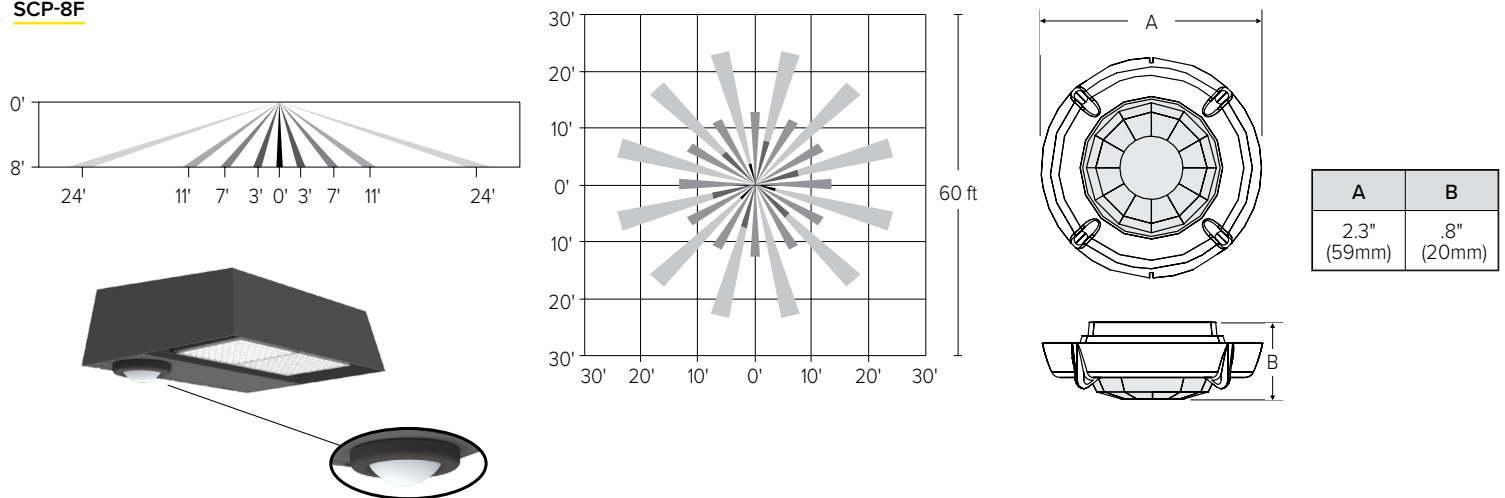

RWL1/RWL2 LED WALLPACK

SCP-20F

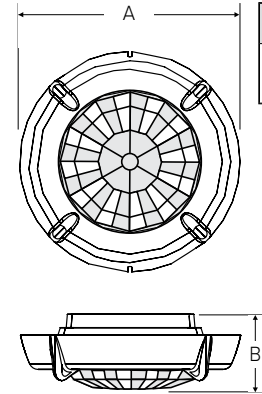
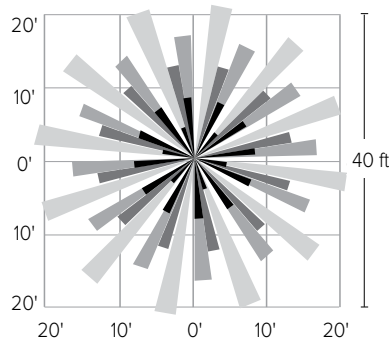
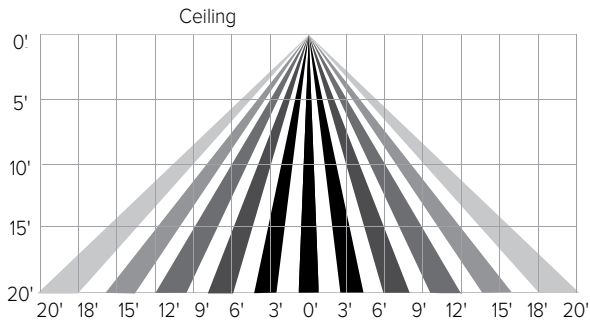

A	B
2.3" (59mm)	.8" (20mm)

SITESYNC 7-PIN MODULE

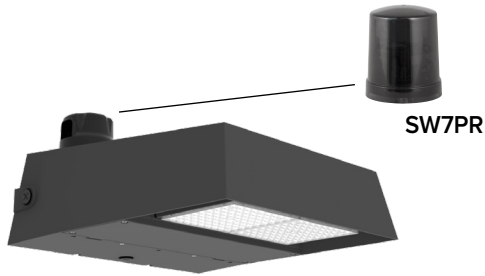

- SiteSync features in a new form
- Available as an accessory for new construction or retrofit applications (with existing 7-Pin receptacle)